





Name: WW Date: 13/11/2016 City / Country: HONG KONG Race: _____ Track: ACO
 Temperature Track: _____ Temperature Air: 25°C Track Surface: Carpet Asphalt Track Layout: Technical Mixed Fast
 Best Lap: _____ Total Time _____ Lap _____

Memo:

Transmission
 Gear Differential : or Locker : 
 Differential Oil : 7000 CST
 Oil Weight : _____
 Memo :

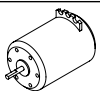



Gear Ratio
 Pinion/ T: 54 Spur Gear/ T: 100 
 Spur Gear / Pinion x 1.9 = Final Drive Ratio: 3.5:1
 (Shaft Pulley : 38T / Diff. Pulley: 20T = 1.9 Internal Gear Ratio)
 Memo :

Power
 Motor : Team Powers Actinium V2 Esc : ORCA 
 End Bell Timing: 0°
 Batteries : ORCA
 Cooling Fan: Yeah Racing 30mm
 Esc Setting / Memo :
ESC: Drag Brake 20%, Binky

Front	Suspension	Rear
<u>500 CST</u>	Shock Oil <u>300 CST</u> 	<u>300 CST</u>
<u>0%</u>	Rebound <u>0%</u>	<u>0%</u>
<u>1 Hole</u>	Piston <u>2 Hole</u>	<u>2 Hole</u>
<u>N/A</u>	Foam Insert <u>N/A</u>	<u>N/A</u>
<u>MST 210154-1 Silver</u>	Spring <u>MST 210154-4 White</u>	
<u>N/A</u>	Anti-Roll Bar <u>N/A</u>	

Memo : Soft Rear Setup, more Grip

Front	Wheel / Tires	Rear
<u>Team Powers 36R</u>	Tires <u>Team Powers 36R</u> 	
<u>SPIDER Red</u>	Inserts _____	
<u>5-10mins</u>	Additive <u>SPIDER Red</u>	
	Additive Timing <u>5-10mins</u>	

Front Left  Front Right  Rear Left  Rear Right 
 Treated Area

Memo :

Other
 Body: 1. MON-TECH Cooper
2. ABC Hobby City Wing: TRG5017 Cut
 Gyro: N/A
 Memo :

Memo :

Front

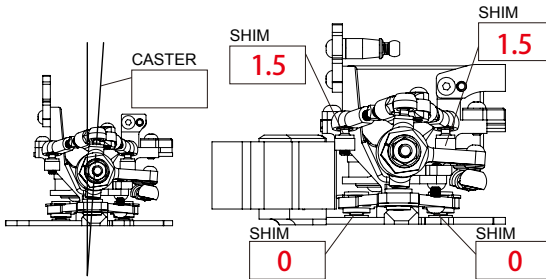

Rear

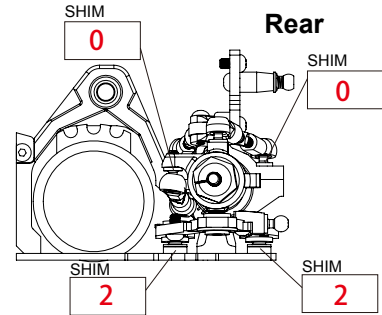

Front

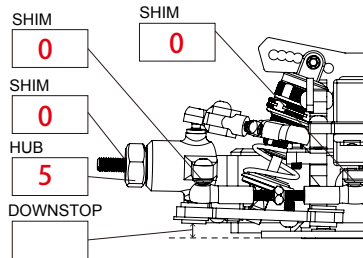

Rear

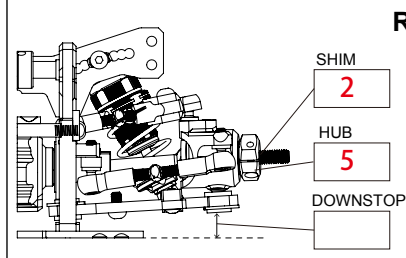

Front

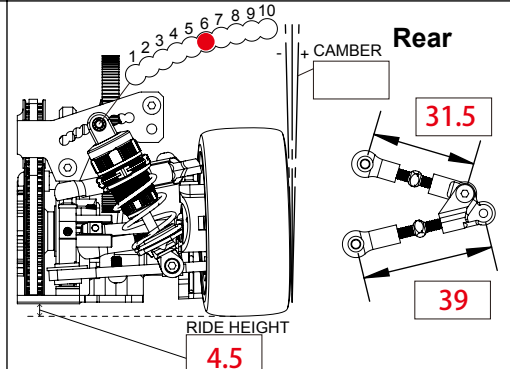
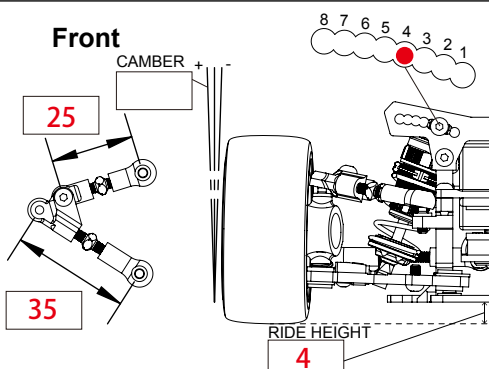

Rear Active Toe In Position

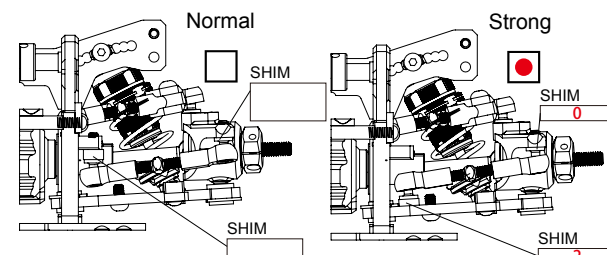

Memo:

